

ELKA

BARRIER SYSTEMS

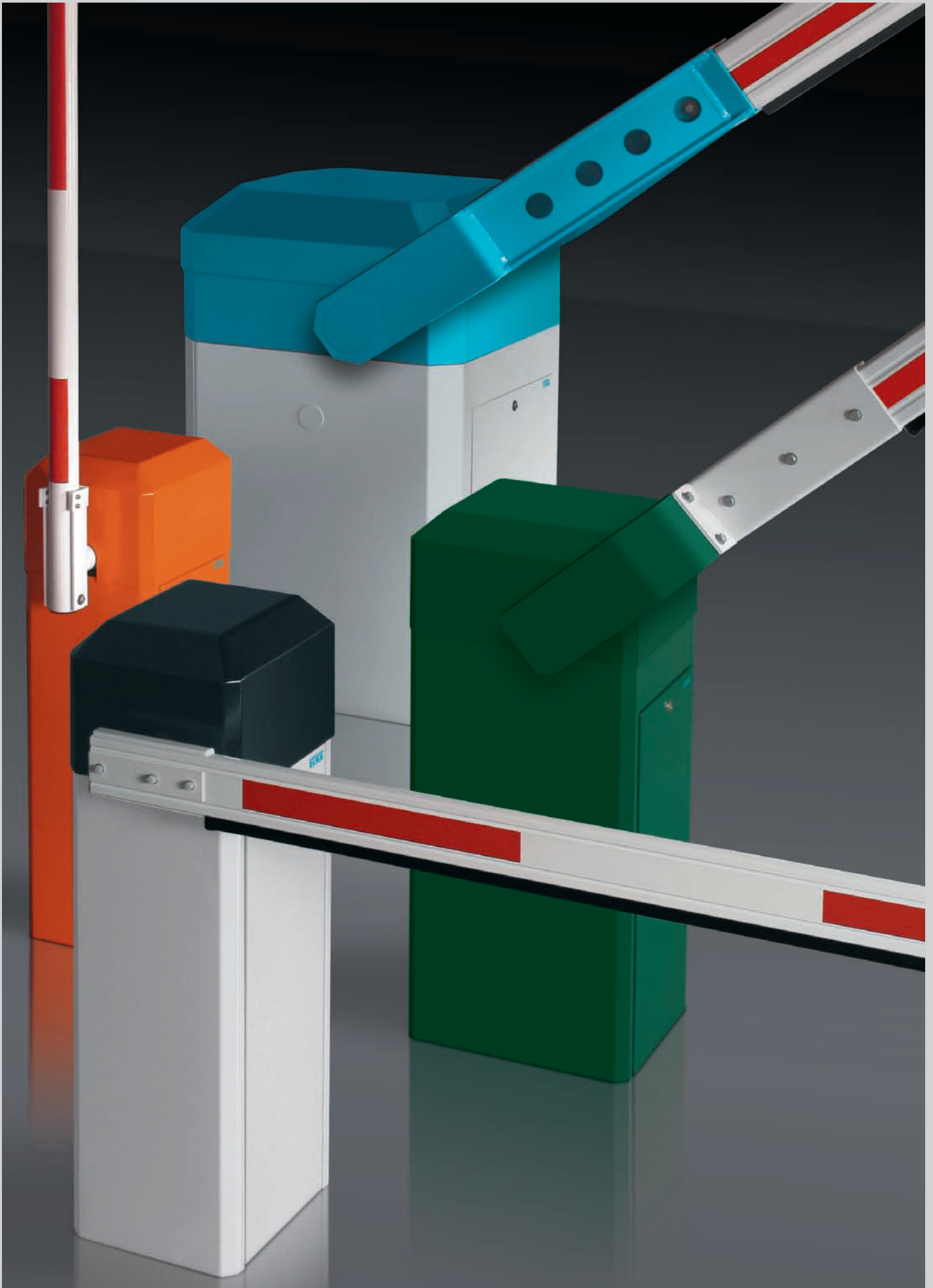



ELKA Novelties

MO 64 "Plus"

The barrier controller with 3 integrated 1-channel loop detectors, network-compatible via modules TCP/IP or RS 485.

Protection rating IP64

The series "Parking", "Industrial" and "Toll Station" are optionally available as IP64 version, dust-proof and protected against water splashes.

Certified according to DIN 55 350 - 18 - 4.3.4.

ES 35HS

The new "Parking" barrier up to 3,500mm boom length

ES 60HS

The new "Industrial" barrier up to 6,000mm boom length

ELKA Standards

Consistent quality

Aluminium housing, powder coated. 10 years warranty against rust perforation.

Many years of experience

50,000 ELKA barriers in use worldwide are the guarantee for a sophisticated technology.

Made in Germany

ELKA engineers develop barriers which meet the highest requirements. The assembly at the factory in Tönning takes place according to specified quality standards. Each barrier is being tested before dispatch.

Easy to install

ELKA barriers are usable left/right without alteration and are equipped with a convenient terminal row.

The barrier controllers

MO 63 "Komfort"

The MO 63 proves itself daily in more than 50,000 barriers. It still is the suitable controller for many applications.

MO 64 "Plus"

The MO 64 has three integrated 1-channel loop detectors. It is network-compatible via modules TCP/IP or RS 485.



Technical data	MO 63 "Komfort"	MO 64 "Plus"
Range of application	Series "Parking", "Industrial", "Koloss"	Series "Parking", "Industrial", "Koloss"
Loop detectors	Socket for 1-channel plus 2-channel detector	Three 1-channel detectors integrated
Module TCP/IP or RS 485	-	optional
Multi-functional relay (make contact), potential-free, max. 24V, 1A	-	4 (freely programmable)
Multi-functional relay (make contact), 230V, max. 120W	-	2 (freely programmable)
4x7-segment-display	-	●
Input for constant open	●	●
Input for constant closed	●	●
Cycles counter	-	●
Service counter, settable	-	●
Reset-function	-	●
Error memory	-	●
Automatic closure	0-300s programmable	0-655s programmable
Pre-warning time OPEN	1.5s or 4s programmable	0-655s programmable
Pre-warning time CLOSE	4s programmable	0-655s programmable
12Vdc and 24Vdc, stabilized, each 500mA, together 700mA, for periphery equipment	●	●
Flashing light 230V connectable	●	●
Traffic light connection, 230V, red or green	●	●
Photo-cell connection with testing function for max. 6 photo-cells	●	●
Running time control	●	●
Re-opening on obstacles without safety contact profile	●	●
Status indication	●	●
One-button operation with serial switching	●	●
Three-button operation (OPEN-STOP-CLOSE)	●	●
Dead man´s mode	-	selectable
Indication boom open/closed	●	●
Vehicle counter	-	●
Freeze mode selectable	-	●
Barrier reverses immediately after a definite closing signal	selectable	selectable
Storing of opening signals	selectable (up to 2 signals)	selectable (up to 9 signals)
Socket for radio remote control receiver	●	●
TRIACS	●	●
Information is saved during power failure	●	●
Power supply	230V/50Hz	230V/50Hz

● Standard - not available

Series "Parking"

ES 25 to ES 40

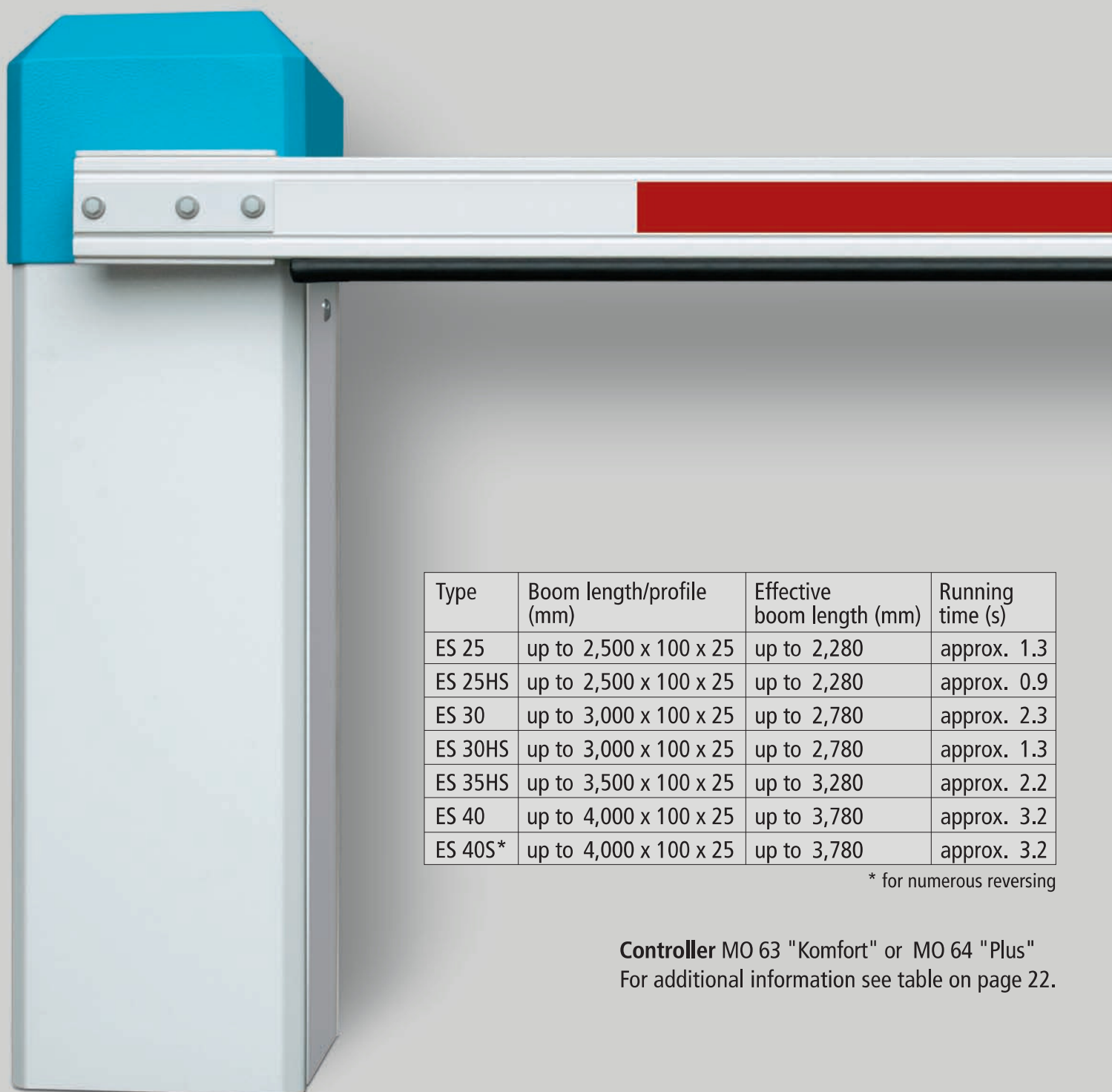

Type	Boom length/profile (mm)	Effective boom length (mm)	Running time (s)
ES 25	up to 2,500 x 100 x 25	up to 2,280	approx. 1.3
ES 25HS	up to 2,500 x 100 x 25	up to 2,280	approx. 0.9
ES 30	up to 3,000 x 100 x 25	up to 2,780	approx. 2.3
ES 30HS	up to 3,000 x 100 x 25	up to 2,780	approx. 1.3
ES 35HS	up to 3,500 x 100 x 25	up to 3,280	approx. 2.2
ES 40	up to 4,000 x 100 x 25	up to 3,780	approx. 3.2
ES 40S*	up to 4,000 x 100 x 25	up to 3,780	approx. 3.2

* for numerous reversing

Controller MO 63 "Komfort" or MO 64 "Plus"
For additional information see table on page 22.

Boomholder
left/right

Emergency release

Gearbox

Maintenance
mains power outlet

Motor

No springs =
wear-free

Controller

Terminal row with
2 sockets for loop
detectors -
1x1-channel plus 1x2-channel,
3 loops connectable



With MO 63 "Komfort"

Series "Industrial"

ES 50 to ES 80

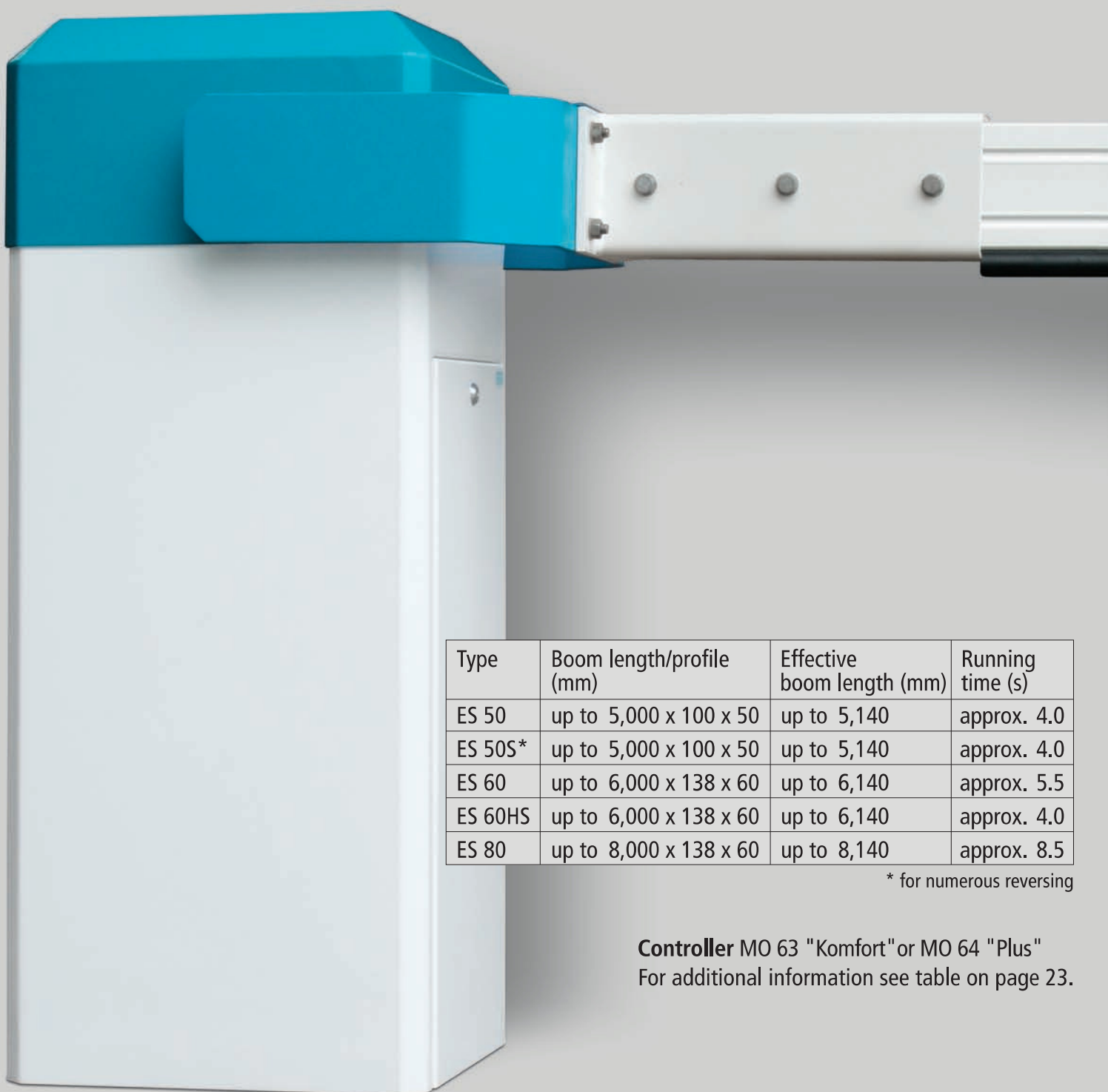

Type	Boom length/profile (mm)	Effective boom length (mm)	Running time (s)
ES 50	up to 5,000 x 100 x 50	up to 5,140	approx. 4.0
ES 50S*	up to 5,000 x 100 x 50	up to 5,140	approx. 4.0
ES 60	up to 6,000 x 138 x 60	up to 6,140	approx. 5.5
ES 60HS	up to 6,000 x 138 x 60	up to 6,140	approx. 4.0
ES 80	up to 8,000 x 138 x 60	up to 8,140	approx. 8.5

* for numerous reversing

Controller MO 63 "Komfort" or MO 64 "Plus"
For additional information see table on page 23.

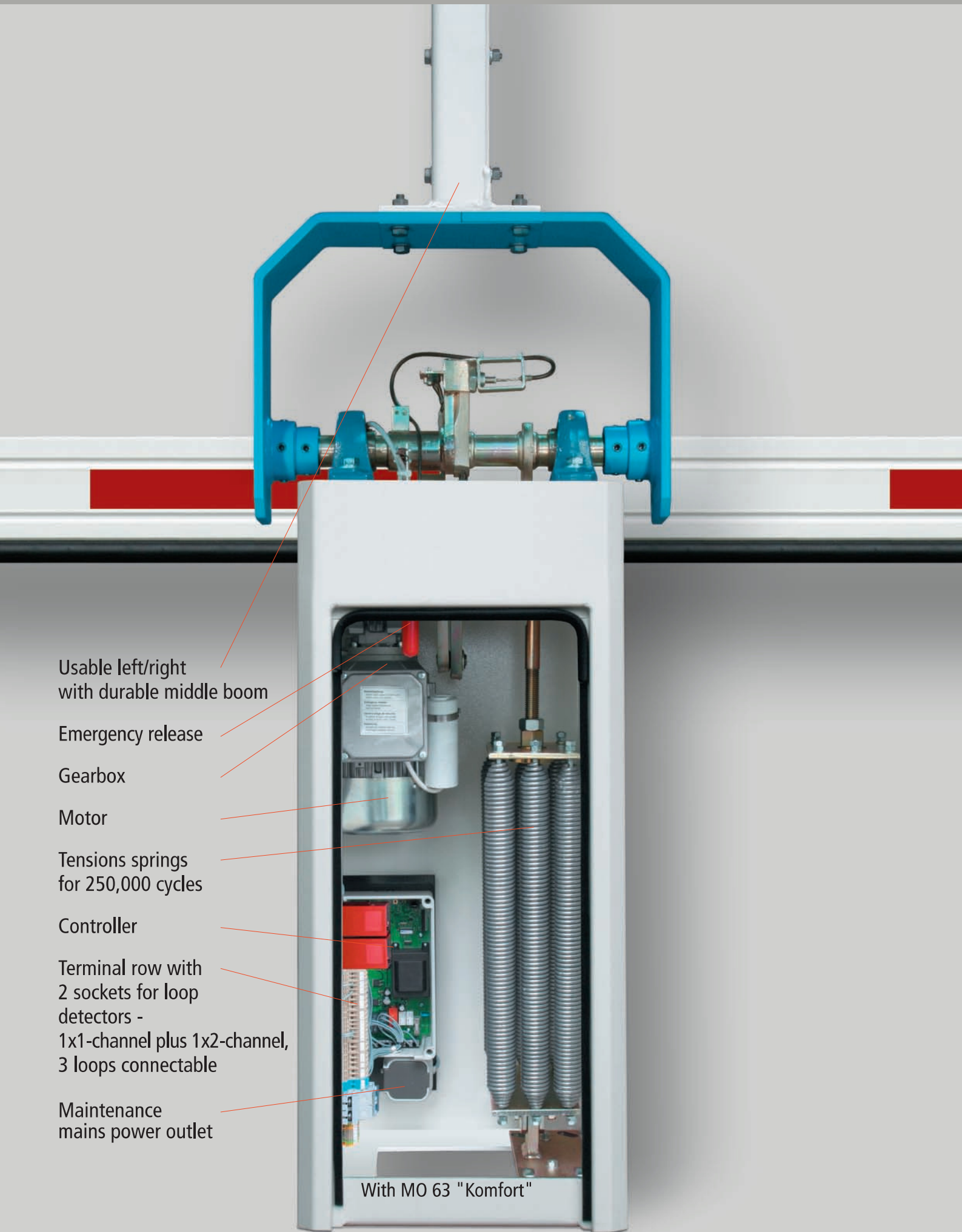

Usable left/right with durable middle boom

Emergency release

Gearbox

Motor

Tensions springs for 250,000 cycles

Controller

Terminal row with 2 sockets for loop detectors - 1x1-channel plus 1x2-channel, 3 loops connectable

Maintenance mains power outlet

With MO 63 "Komfort"

Series "Koloss"

KOLOSS 60 to KOLOSS 120

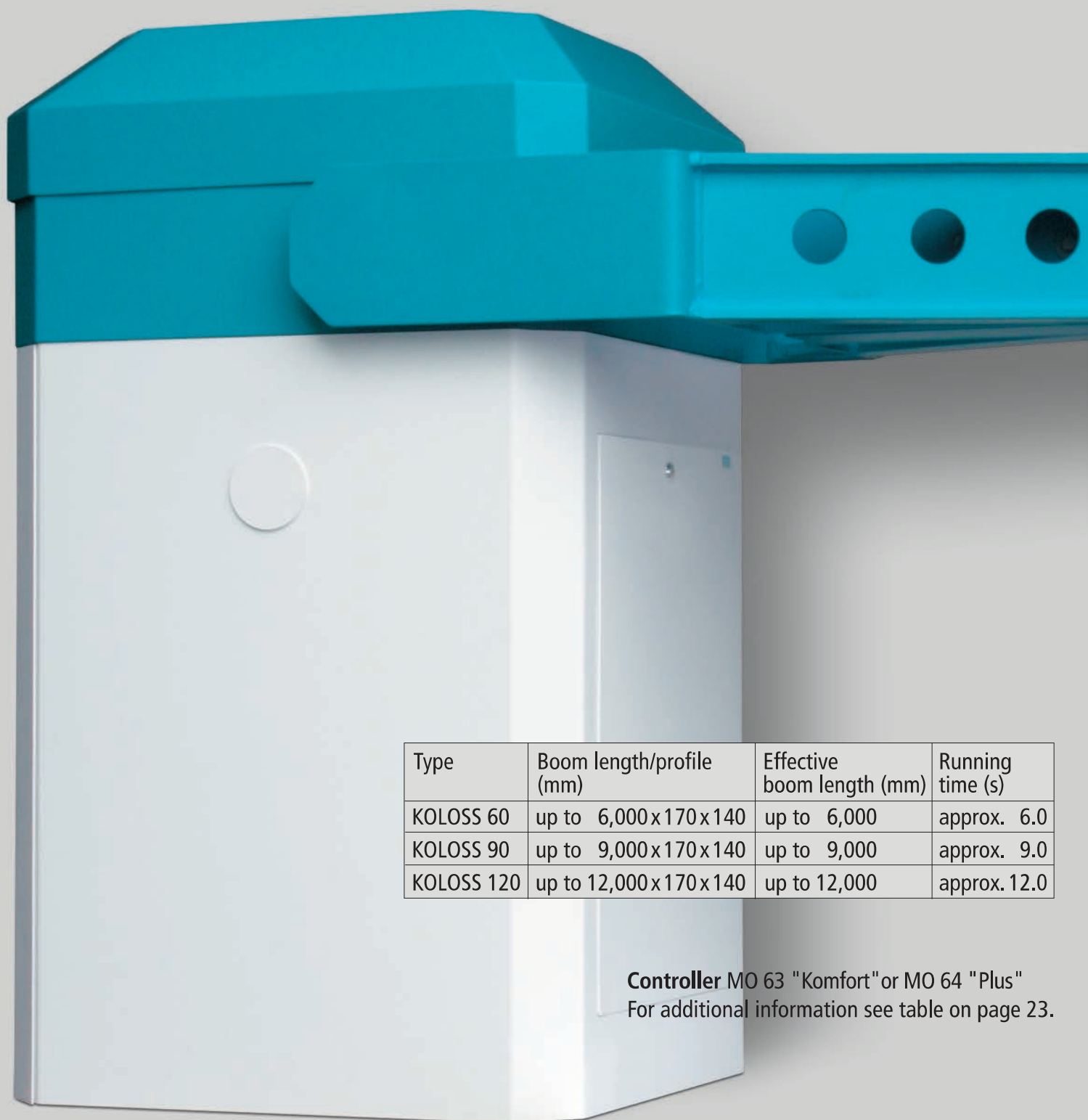

Type	Boom length/profile (mm)	Effective boom length (mm)	Running time (s)
KOLOSS 60	up to 6,000x170x140	up to 6,000	approx. 6.0
KOLOSS 90	up to 9,000x170x140	up to 9,000	approx. 9.0
KOLOSS 120	up to 12,000x170x140	up to 12,000	approx. 12.0

Controller MO 63 "Komfort" or MO 64 "Plus"
 For additional information see table on page 23.

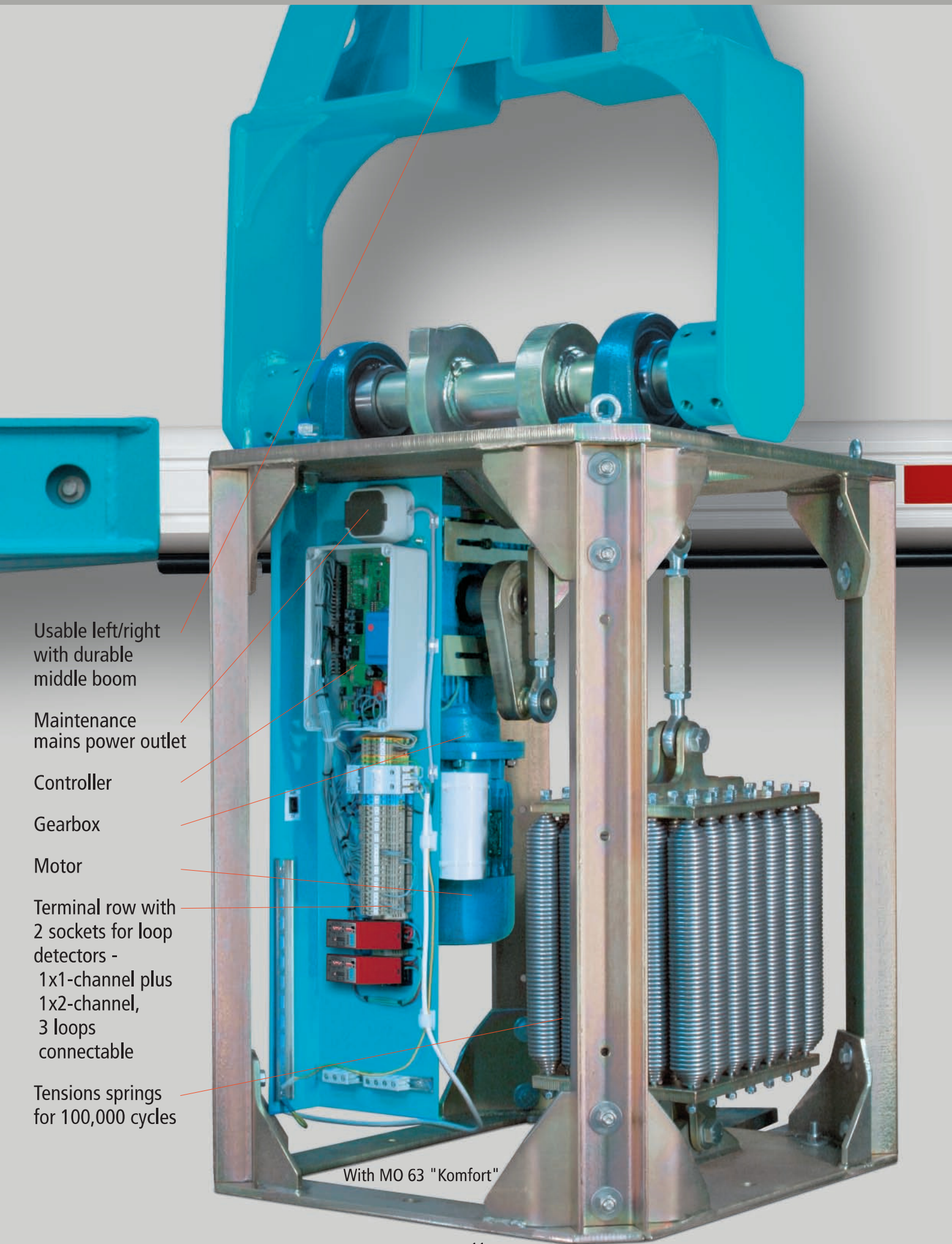

Usable left/right
with durable
middle boom

Maintenance
mains power outlet

Controller

Gearbox

Motor

Terminal row with
2 sockets for loop
detectors -
1x1-channel plus
1x2-channel,
3 loops
connectable

Tensions springs
for 100,000 cycles

With MO 63 "Komfort"

Series "Toll Station"

MAUT 20 to MAUT 35

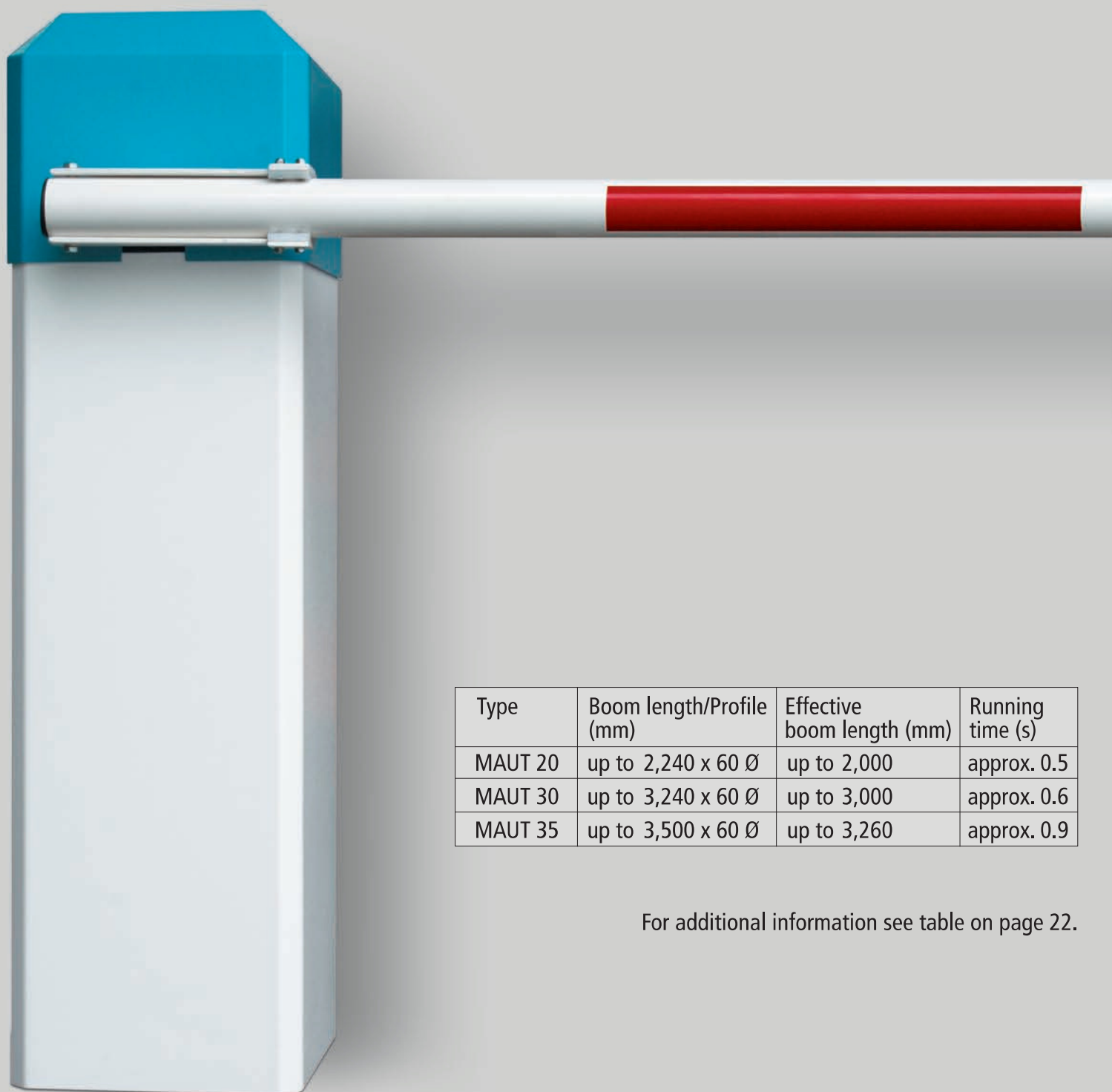

Type	Boom length/Profile (mm)	Effective boom length (mm)	Running time (s)
MAUT 20	up to 2,240 x 60 Ø	up to 2,000	approx. 0.5
MAUT 30	up to 3,240 x 60 Ø	up to 3,000	approx. 0.6
MAUT 35	up to 3,500 x 60 Ø	up to 3,260	approx. 0.9

For additional information see table on page 22.

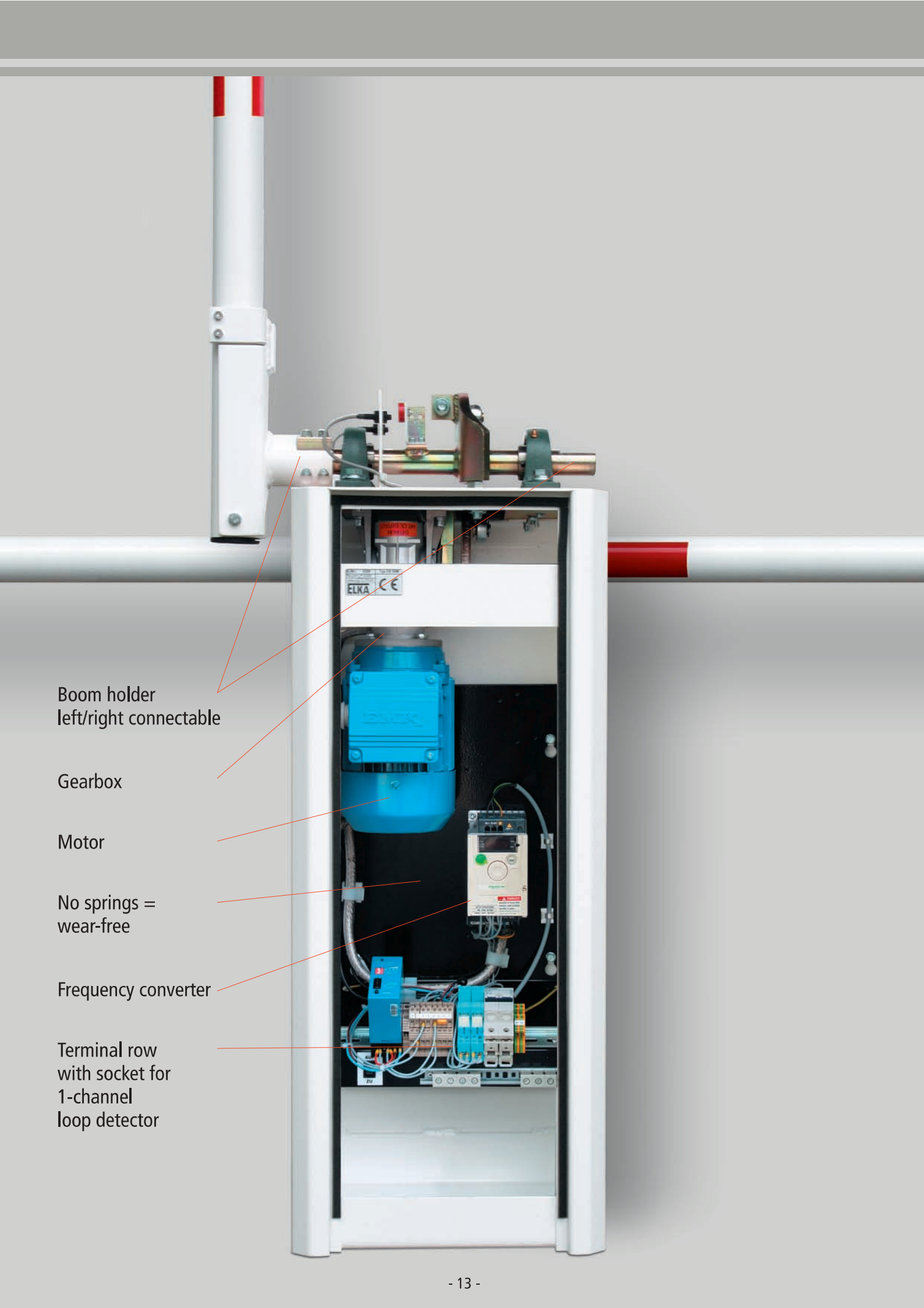

Boom holder
left/right connectable

Gearbox

Motor

No springs =
wear-free

Frequency converter

Terminal row
with socket for
1-channel
loop detector

Accessories

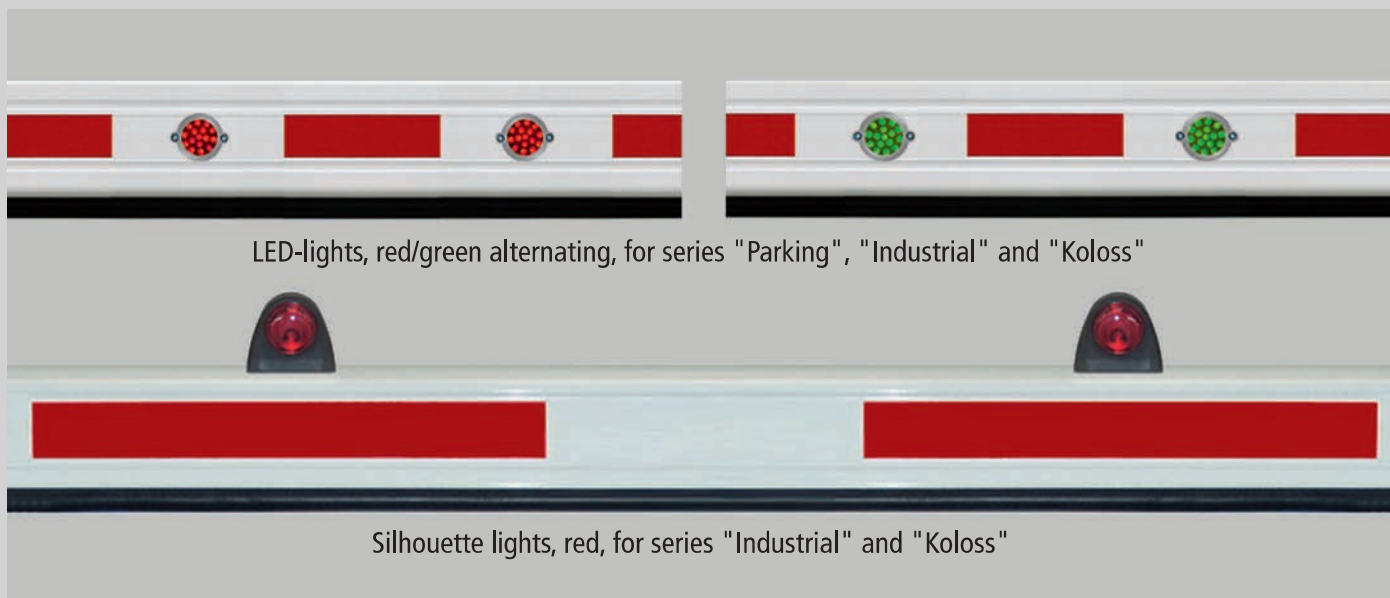
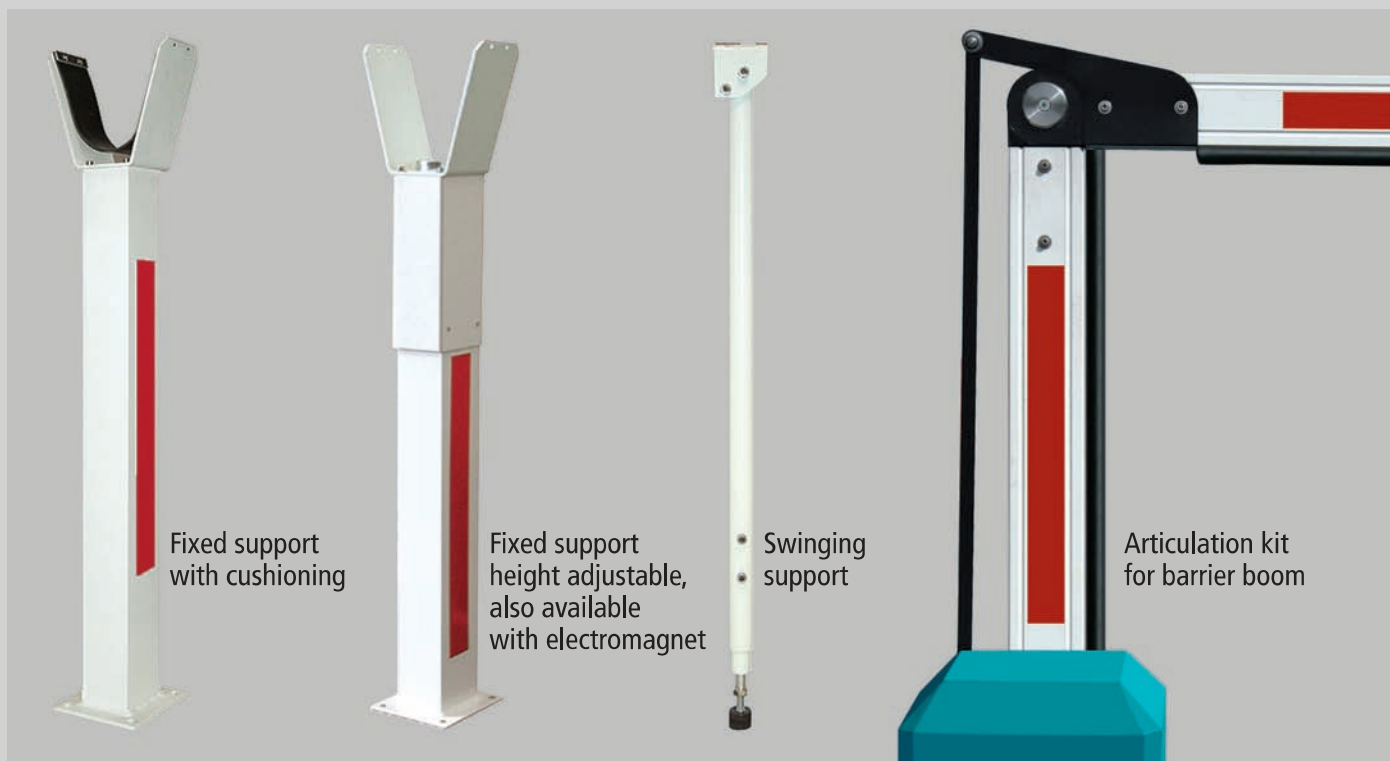

Accessories



Folding skirts and folding top and bottom skirts

Folding skirt 75
for ES 50S, ES 60, ES 80 and KOLOSS

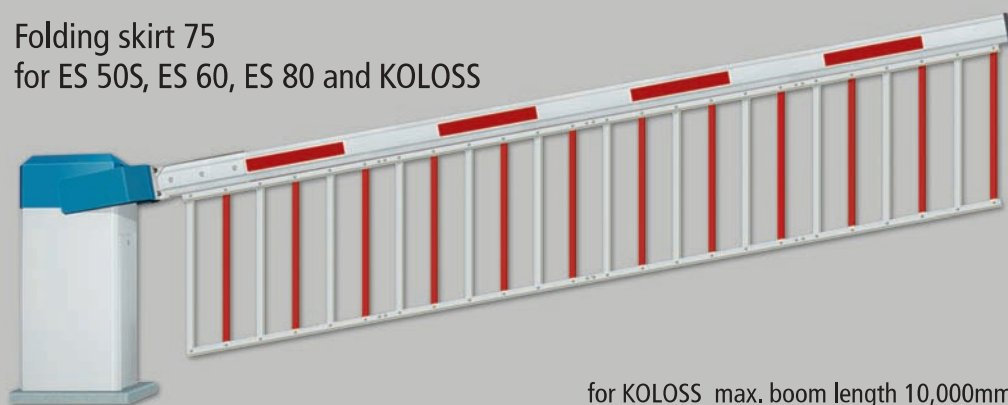

for KOLOSS max. boom length 10,000mm

Folding skirt 75,
flat-rolled aluminium,
15x3mm,
white or red/white,
750mm high,
weight: 1.5kg/m

Folding skirt 150
for ES 60, ES 80 and KOLOSS



for ES 60 max. boom length 4,500mm
for ES 80 max. boom length 6,000mm
for KOLOSS max. boom length 6,000mm

Folding skirt 150,
aluminium circular
tubes, 20mm, white,
1,500mm high,
weight: 3.9kg/m

Folding top and bottom skirt 150
for ES 60, ES 80 and KOLOSS

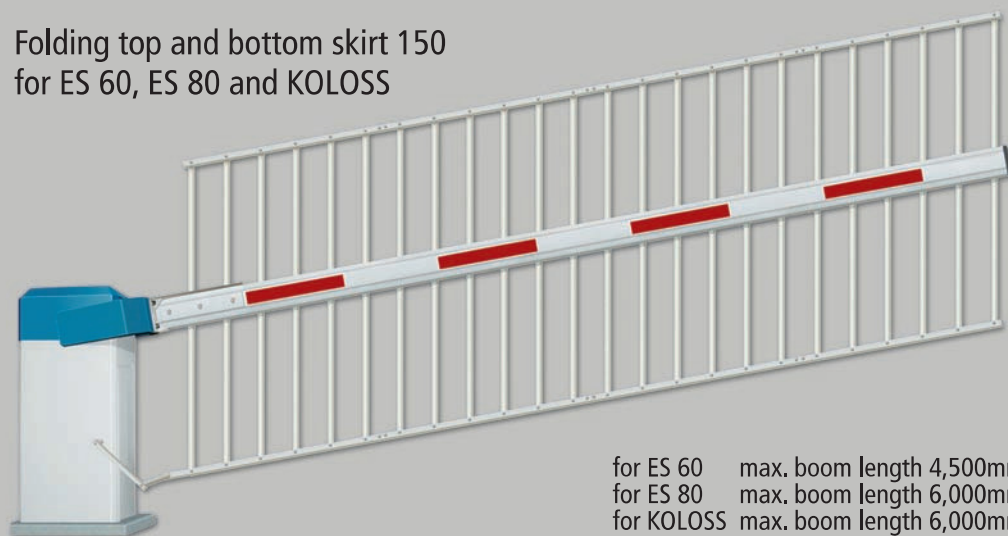

for ES 60 max. boom length 4,500mm
for ES 80 max. boom length 6,000mm
for KOLOSS max. boom length 6,000mm

Folding top and
bottom skirt 150,
aluminium circular
tubes, 20mm, white,
1,500mm high,
weight: 3.8kg/m

Induction loop for unobstructed entrance and exit

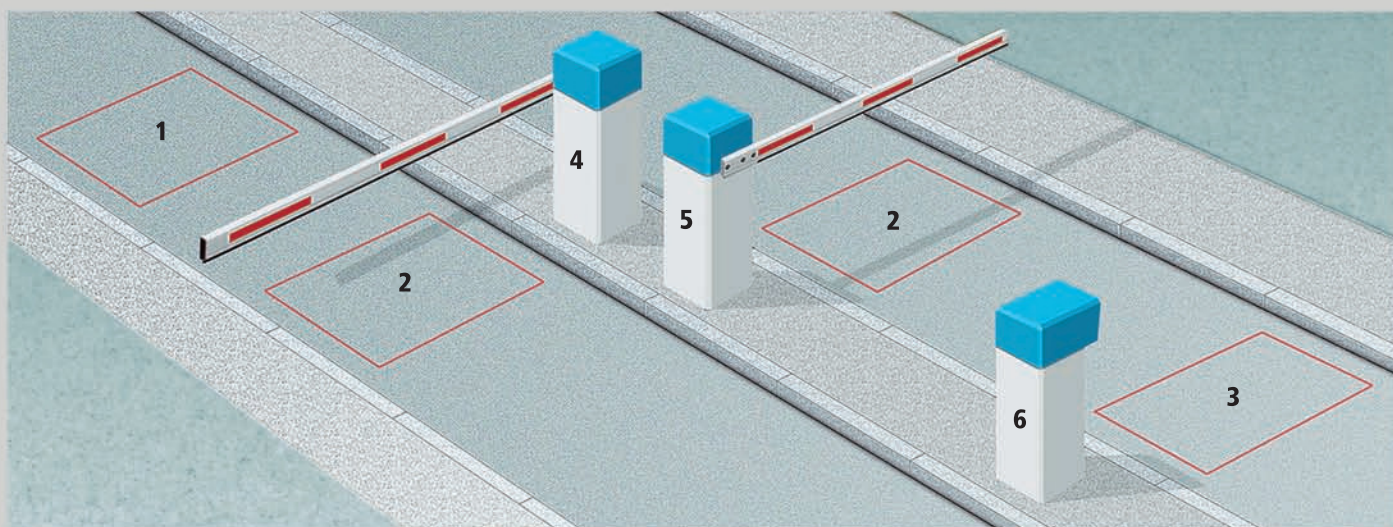

- 1 Induction loop for automatic opening 3 Induction loop indicating that a vehicle is present 5 Entrance barrier
 2 Induction loop for safety and closing 4 Exit barrier 6 Entrance terminal with access control

4 Variants

Variant 1

Access control e.g. with a key switch, when a vehicle is on the loop. Automatic exit with an opening loop. Safety of vehicles under the boom and closing of the barrier with induction loop.

Variant 2

Automatic entrance with an opening loop. Exit controls e.g. with tokens. Safety of vehicles under the boom and closing of the barrier with induction loop.

Variant 3

Access control e.g. with a key switch, when a vehicle is on the loop. Safety of vehicles under the boom and closing of the barrier with induction loops.

Variant 4

Access control e.g. with a key switch, when a vehicle is on the loop. Automatic exit with an opening loop. Safety of vehicles under the boom and closing of the barrier with induction loops.

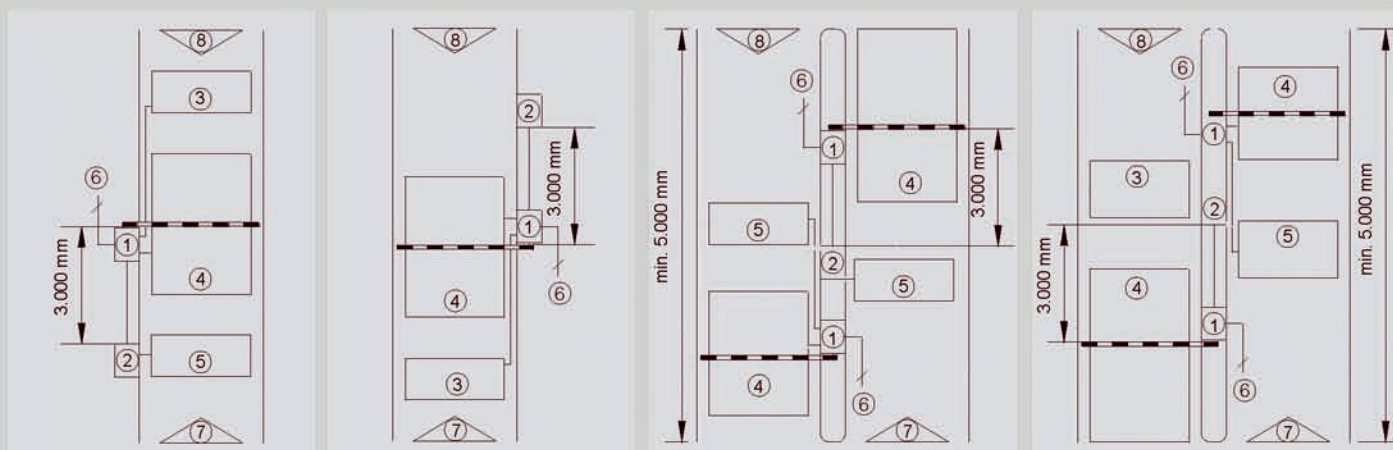

- 1 Barrier 2 Access control devices 3 Opening loop 4 Safety/closing loop 5 Presence loop 6 Mains supply 7 Entrance 8 Exit

Aluminium pillars and housings

Pillars with lockable, removable front panels

- 1 Photoelectric barrier - pillar 1
- 2 Photoelectric barrier - pillar 2
- 3 Pillar for cars 1
- 3a Pillar for cars/transporters
- 4 Pillar for cars 2

Housing with hinged hoods and removable mounting panels

- 5 Housing for cars - small
- 6 Housing for cars - large
- 7 Housing for transporters/minibuses
- 8 Housing for cars/trucks

No.	Examples for use	Size (w×l×h) mm	Assembly dimensions (w×l×h) mm
1	1 Photoelectric barrier	80x100x550	75x80x160
2	2 Photoelectric barriers	80x100x1,100	75x80x160
3	Key switch, magnetic card reader	80x100x1,100	75x80x160
3a	2 Key switches, 2 magnetic card readers	80x100x1,850	top: 75x80x160 bottom: 75x70x160
4	Card readers, code switches	145x145x1,100	125x130x160
5	Various access control systems, intercom systems	350x300x1,100	330x250x195
6	Various access control systems, intercom systems	400x450x1,220	490x400x265
7	Various access control systems, intercom systems	350x300x1,850	330x250x195
8	Various access control systems, intercom systems	350x300x2,250	top: 330x250x195 bottom: 340x220x220

Colours: Hood blue (RAL 5012) Housing white (RAL 9010) - RAL



sings

Ground plate mm	Installing through ...	Weight kg
160x140	Removable, lockable front panel	2.5
160x140	Removable, lockable front panel	4.7
160x140	Removable, lockable front panel	4.7
180x200	Removable, lockable front panel	7.0
220x220	Removable, lockable front panel	7.0
Internal mounting panel, incl. drilling template	Lockable access panel, hinged hood	20.0
Internal mounting panel, incl. drilling template	Lockable access panel, hinged hood	28.5
Internal mounting panel, incl. drilling template	Lockable access panel, hinged hood	28.0
Internal mounting panel, incl. drilling template	Lockable access panel, hinged hood	30.5

custom colours on request (additional charge)



Manual barriers

up to 7,500mm effective boom length



Stabilization rope for EH 55L and up

Locking devices



Locking device 1 and 2*
Profile cylinder lock at
the barrier stand
(optional)

Locking device 3 and 4*
Fire emergency release and
profile cylinder lock at the
barrier stand (optional)

Profile cylinder lock
at the fixed support
(optional)

Fire emergency release
at the fixed support
(optional)

Bolt for padlock
-on site- at the fixed support
(optional)

* Version 2 and 4 with forced closure

Barrier stand

made of galvanised steel, RAL 3002

Catch-bolt

for automatic blocking

Barrier boom

Made of aluminium, powder coated, white RAL 9010, with red reflective stripes, rubber tube on the underside

Usage left/right

General technical data	EH 25L	EH 30L	EH 35L	EH 40L	EH 45L	EH 50L	EH 55L	EH 60L	EH 65L	EH 70L	EH 75L
Effective boom length (mm)	2,500	3,000	3,500	4,000	4,500	5,000	5,500	6,000	6,500	7,000	7,500
Boom dimensions (mm)	100x50										
Boom weight (kg)	5.3	6.4	7.4	8.4	9.5	10.5	16.6	17.6	18.7	19.7	20.7
Stabilization rope/boom	no						yes				
Swinging support or fixed support	optional				required						
Counterweights (quantity)	0	2	2	2	4	6	12	14	16	18	20

Synoptical table series "Parking"

	ES 25	ES 25HS	ES 30	ES 30HS	ES 35HS	ES 40	ES 40S
Barrier controller	MO 63 "Komfort" or MO 64 "Plus"						
Boom length (mm)	2,500	2,500	3,000	3,000	3,500	4,000	4,000
Effective boom length (mm)	2,280	2,280	2,780	2,780	3,280	3,780	3,780
Running time approx. (s)	1.3	0.9	2.3	1.3	2.2	3.2	3.2
Duty cycle	100%	100%	100%	100%	100%	100%	100%
Boom dimensions h/w (mm)	100x25	100x25	100x25	100x25	100x25	100x25	100x25
Boom weight (kg)	4.0	4.0	4.7	4.7	5.2	6.0	6.0
Boom connector	left/right connectable						
Round boom	Ø 60mm, optional						
Swinging support or fixed support	no					optional	
Boom articulation kit optional	yes						
Housing w/l/h (mm)	aluminium, 300 x 350 x 1,100						
Standard colour, blue/white	hood RAL 5012, bottom part RAL 9010 - custom colours optional						
Temperature range	- 20°C - + 70°C, optional - 40°C						
IP protection rating	IP44, optional IP64						
Vandalism protection	boom connected with plastic screws as predetermined shearing point when horizontal force is applied						
Barrier weight without boom (kg)	48	48	48	48	48	48	50
Reversing on obstacle	ja						
LED boom lighting, with toggle switch, integrated in the boom, optional	green = boom is open, red = boom is closed or in movement or constant red (not for round boom)						
Mains supply	230V/50Hz - 115V/60Hz version optional						
Drawn power	0.37kW	0.37kW	0.25kW	0.37kW	0.25kW	0.26kW	0.26kW
Max. current consumption	2.5A	2.5A	2.5A	2.5A	2.5A	3.1A	3.1A

Synoptical table series "Toll Station"

	MAUT 20	MAUT 30	MAUT 35
Barrier controller	frequency converter		
Boom length (mm)	2,240	3,240	3,500
Effective boom length (mm)	2,000	3,000	3,260
Running time approx. (s)	0.5	0.6	0.9
Duty cycle	100%	100%	100%
Boom dimensions (mm)	Ø 60	Ø 60	Ø 60
Boom weight (kg)	1.50	2.3	2.6
Boom connector	left/right connectable with clip-out-function		
Housing w/l/h (mm)	aluminium, 300 x 350 x 1,100		
Standard colour, blue/white	hood RAL 5012, bottom part RAL 9010 custom colours optional		
Temperature range	-20°C - +70°C, optional -40°C		
IP protection rating	IP44, optional IP64		
Barrier weight without boom (kg)	48	48	48
Mains supply	230V/50Hz - 115V/60Hz version optional		
Drawn power	0.37kW	0.37kW	0.37kW
Max. current consumption	2.5A	2.5A	2.5A

Synoptical table series "Industrial" and "Koloss"

	ES 50	ES 50S	ES 60	ES 60HS	ES 80	KOLOSS 60	KOLOSS 90	KOLOSS 120
Barrier controller	MO 63 "Komfort" or MO 64 "Plus"							
Boom length (mm)	5,000	5,000	6,000	6,000	8,000	6,000	9,000	12,000
Effective boom length (mm)	5,140	5,140	6,140	6,140	8,140	6,000	9,000	12,000
Running time approx. (s)	4.0	4.0	5.5	4.0	8.5	6.0	9.0	12.0
Duty cycle	100%	100%	100%	100%	100%	100%	100%	100%
Boom dimensions h/w (mm)	100x50	100x50	138x60	138x60	138x60	170x140	170x140	170x140
Boom weight (kg)	10.0	10.0	16.5	16.5	23.0	27.0	58.0	71.5
Usage left/right	yes							
Round boom	Ø 100mm, optional					no		
Swinging support or fixed support	mandatory					optional	mandatory	
Boom articulation kit optional	yes				no			
Folding skirt 75 optional	no	yes		no	yes			up to max. 10,000mm
Folding skirt 150 optional	no		up to max. 4,500mm	no	up to max. 6,000mm			
Folding top/bottom skirt 150 optional	no		up to max. 4,500mm	no	up to max. 6,000mm			
Housing w/l/h (mm)	aluminium, 450 x 400 x 1,100					aluminium, 720 x 656 x 1,250		
Standard colour, blue/white	hood RAL 5012, bottom part RAL 9010 - custom colours optional							
Temperature range	-20°C - +70°C, optional -40°C							
IP protection rating	IP44, optional IP64					IP44		
Barrier weight without boom (kg)	110	110	115	115	118	415	430	465
Reversing on obstacle	yes							
LED boom lighting, with toggle switch, integrated in the boom, optional	green = boom is open, red = boom is closed or in movement or constant red (not for round boom)							
Silhouette light for boom	red							
Mains supply	230V/50Hz - 115V/60Hz version optional							
Drawn power	0.26kW	0.37kW	0.25kW	0.37kW	0.26kW	0.55kW	0.55kW	1.1kW
Max. current consumption	2.5A	2.5A	2.5A	2.5A	3.1A	7.0A	7.0A	10.0A

ELKA barriers comply with the standards 2004/108/EG, 2006/95/EG and 2006/42/EG.
The warranty period for ELKA barriers is 2 years.

Please request detailed brochures - free of charge



Slide gate openers



Swing gate openers



Garage door openers



Radio remote control

